

CURRENT TRANSFORMERS

AST1659 - Protective current transformers

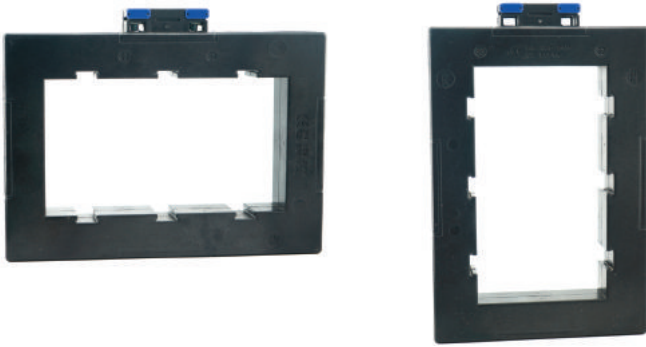

Dimensions:	
AST1659	223 x 171 x 35 mm
AST1659V	155 x 239 x 35 mm
Primary bar:	165 x 90 mm

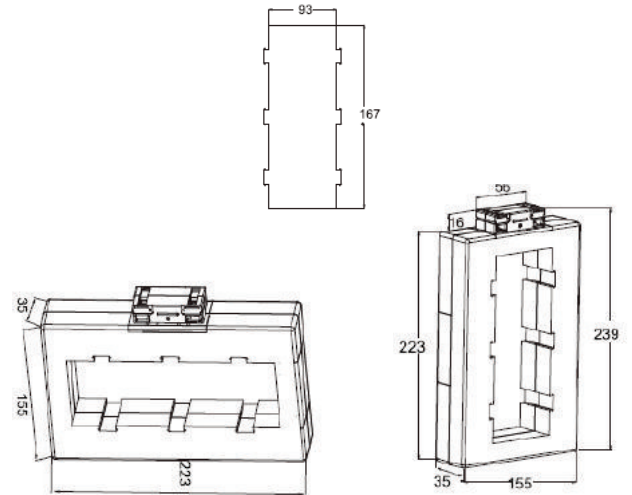

AST1659/AST1659V Technical Features, Executions

Primary rated current A	Rated burdens VA (sec. .../5A)			
	Class 5P5	Class 10P5	Class 5P10	Class 10P10
2000	15	15	3.75	3.75
2500	20	20	5	5
3000	20	20	5	5
3200	20	20	5	5
3500	20	20	5	5
4000	30	30	7.5	7.5
5000	30	30	7.5	7.5
6000	45	45	10	10

Included: Primary busbar

Accessories: mounting feet / Snap on mounting EN 50022-35

AST2065 - Protective current transformers



Dimensions:	
AST2065	265 x 151 x 35 mm
AST2065V	135 x 281 x 35 mm
Primary bar:	205 x 65 mm

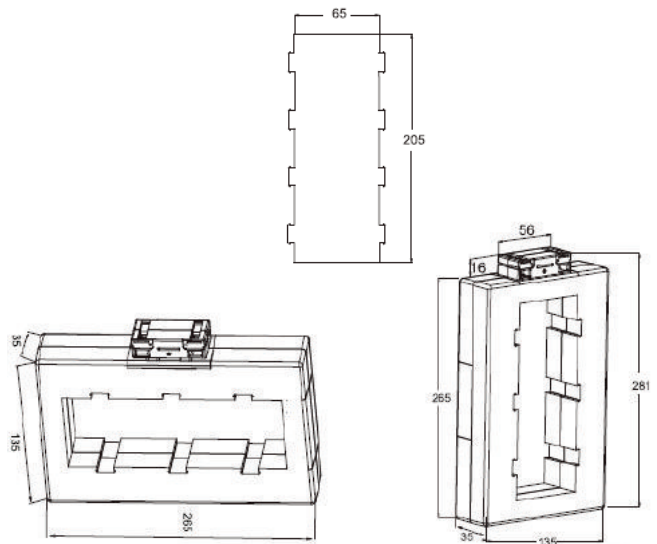

AST2065/AST2065V Technical Features, Executions

Primary rated current A	Rated burdens VA (sec. .../5A)			
	Class 5P5	Class 10P5	Class 5P10	Class 10P10
3000	20	20	5	5
3200	20	20	5	5
3500	20	20	5	5
4000	30	30	7.5	7.5
5000	30	30	7.5	7.5
6000	45	45	10	10

Included: Primary busbar

Accessories: mounting feet / Snap on mounting EN 50022-35